

LIGHT FRAME

SET UP INSTRUCTION

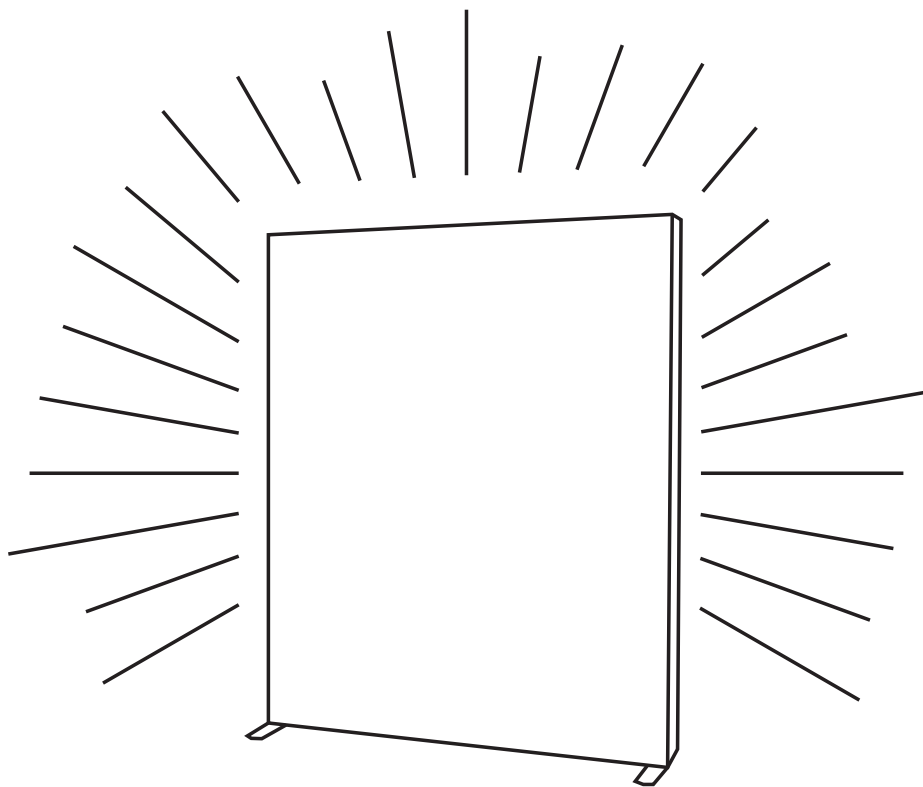

Watch the movie about
Light Frame.

0,96x2,5

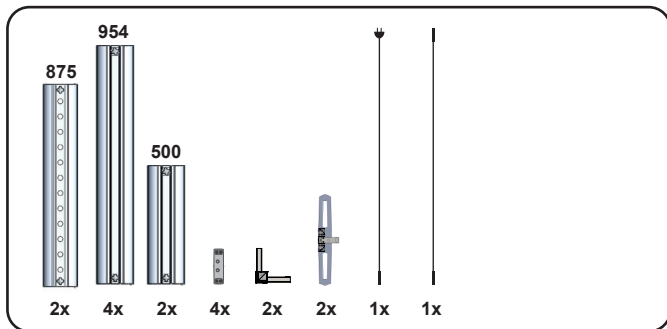

1,96x2,5

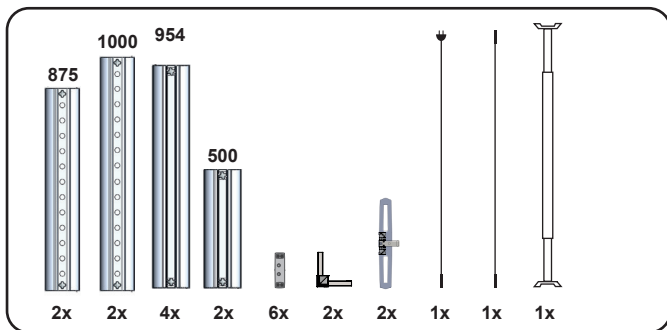

2,96x2,5

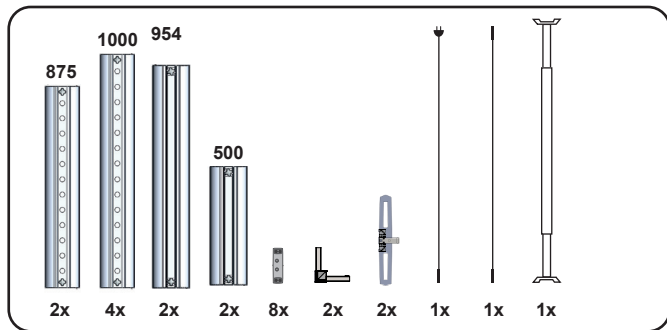

3,96x2,5

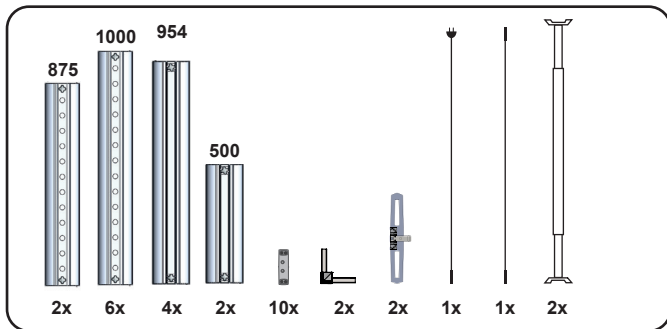

Max. frame width 5 meters, max. input power 500 W

1.

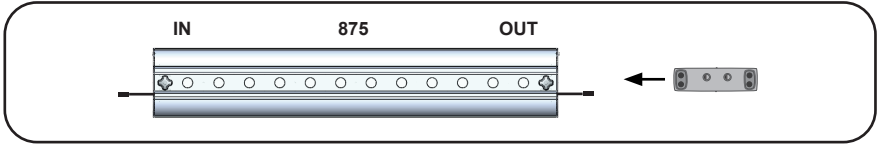

2.

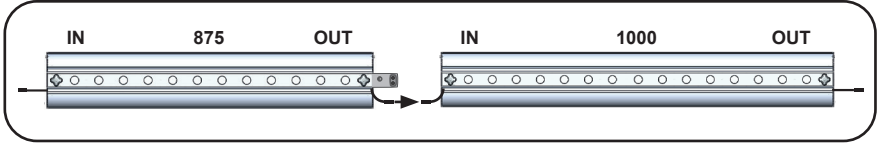

3.

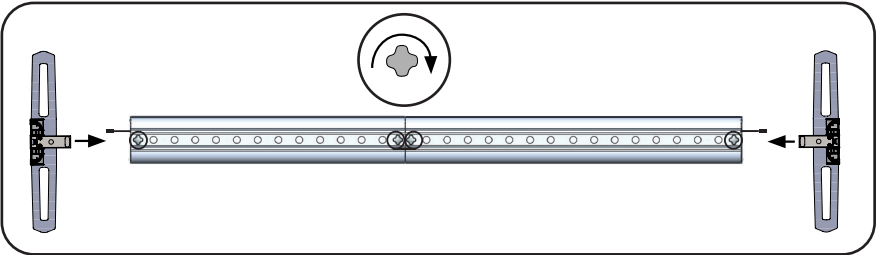

4.

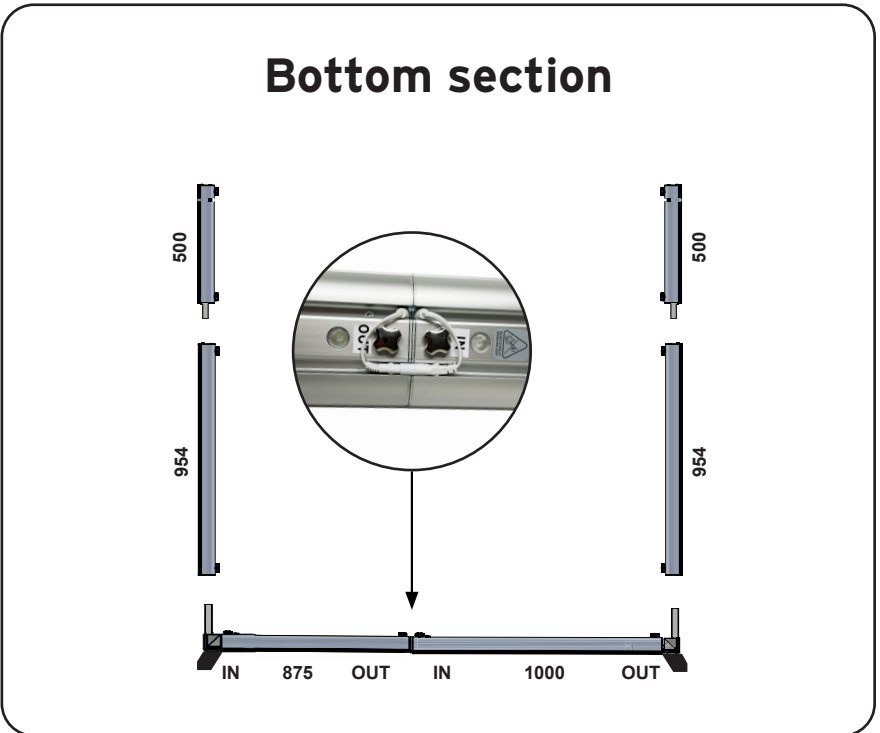

5.

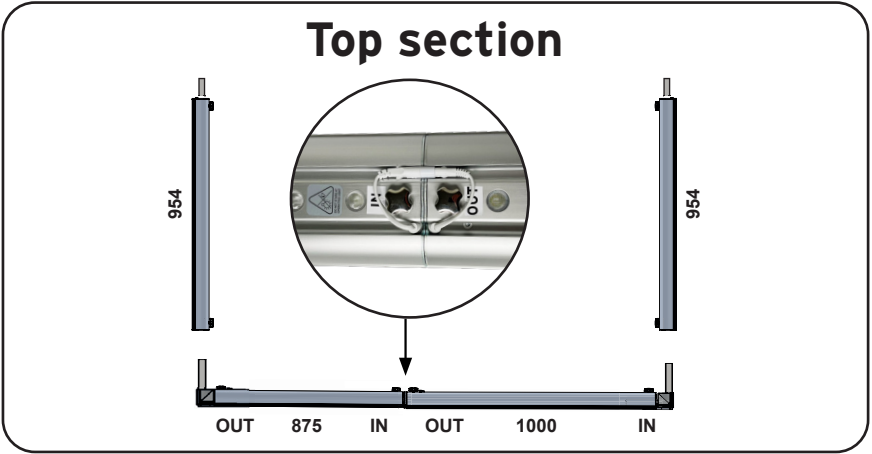

6.

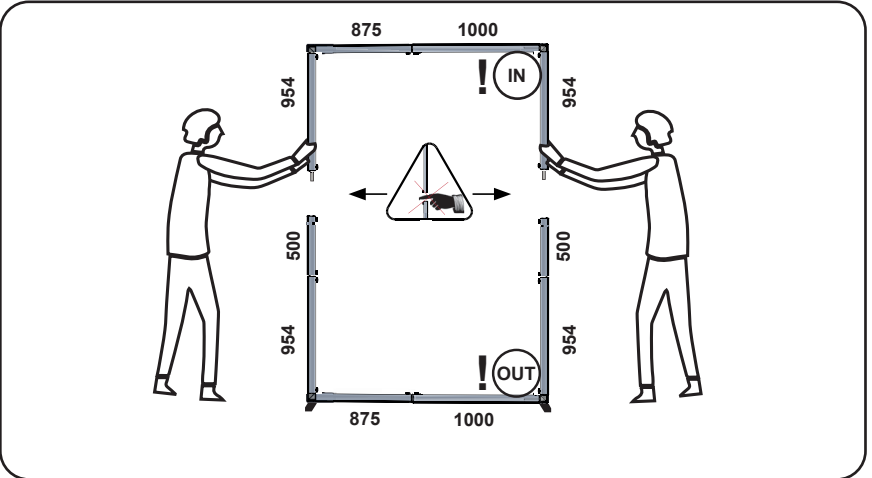

7.

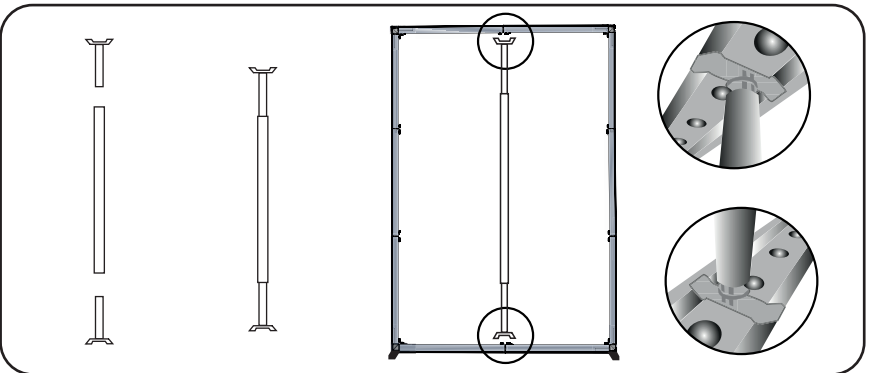

8.

- For indoor use only.

- The luminaire should be positioned so that prolonged staring into the luminaire at a distance closer than 1.58 m is not expected.

- If the external flexible cable or cord of this luminaire is damaged, it shall be exclusively replaced by the manufacturer or his service agent or a similar qualified person in order to avoid a hazard.

- The light source of this luminaire is not replaceable; when the light source reaches its end of life the whole luminaire shall be replaced.

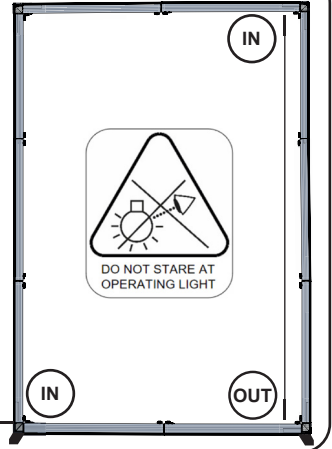

9.

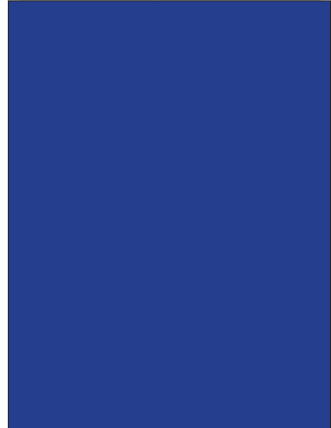
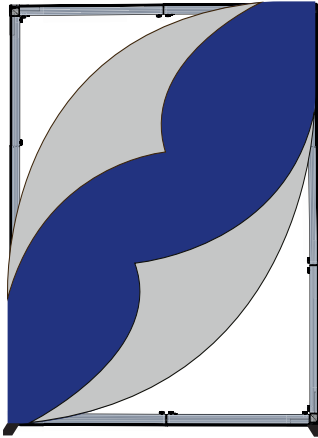
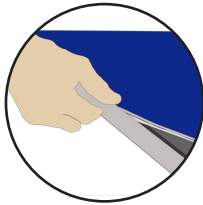

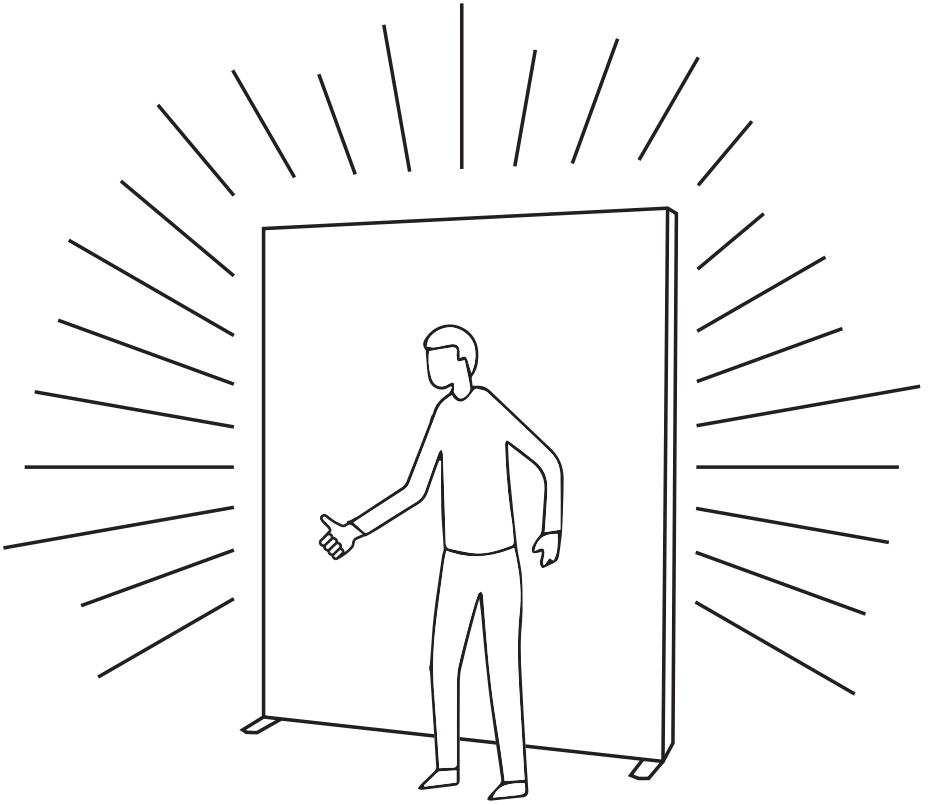

Connectors

Connectors - Classic Frame - Light Frame

Straight Type A

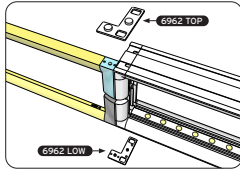

Straight Type B

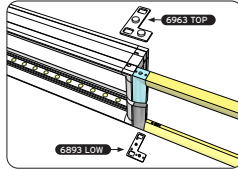

90° Type A

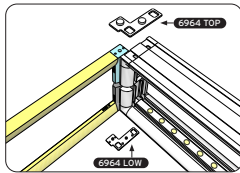

90° Type B

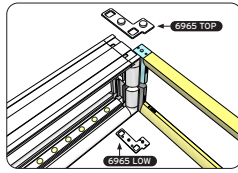

Connectors - Light Frame - Light Frame

Straight

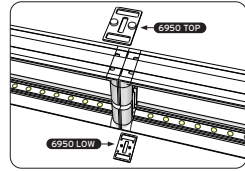

90°

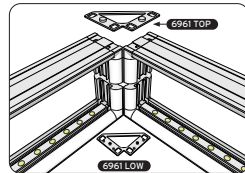

Stabilizing feet

Connecting feet - Classic Frame/Light Frame

Double-sided (Standard)

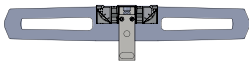

Single-sided (Optional)

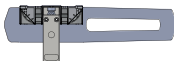

Straight Type B

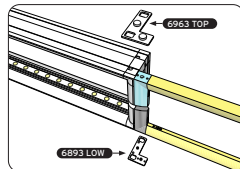

Straight Type A with double sided supporting foot

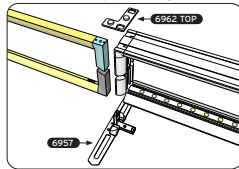

Straight Type B with single sided supporting foot

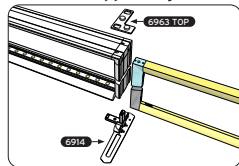

Connecting feet - Light Frame - Light Frame

Straight with double sided connection foot

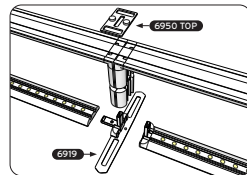

Straight with single sided connection foot

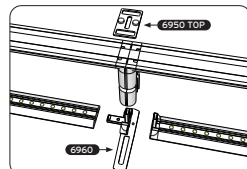



We create marketing tools for professionals

HIGH PERFORMANCE
DISPLAY SYSTEMS

EXPOLINC.COM



Safety tested and approved by Intertek according to:

European Union Standards (CE):

IEC 60598-2-1:1979+A1, EN 60598-1:2015+A1, EN 60598-2-1:1989, IEC 60598-1:2014(AMD1:2017, IEC 62031
IEC 62471:2006



Intertek

Safety tested and approved by Intertek according to:

North American Standards (ETL):

CSA C22.2#250.0:2018 Ed.4, UL 153:2014 Ed13+R:27.Jul2018